

# 5100L Series

L5100L/LM | L5100LC/LMC | L5100LY

HYUNDAI WIA Heavy Duty CNC Turning Center

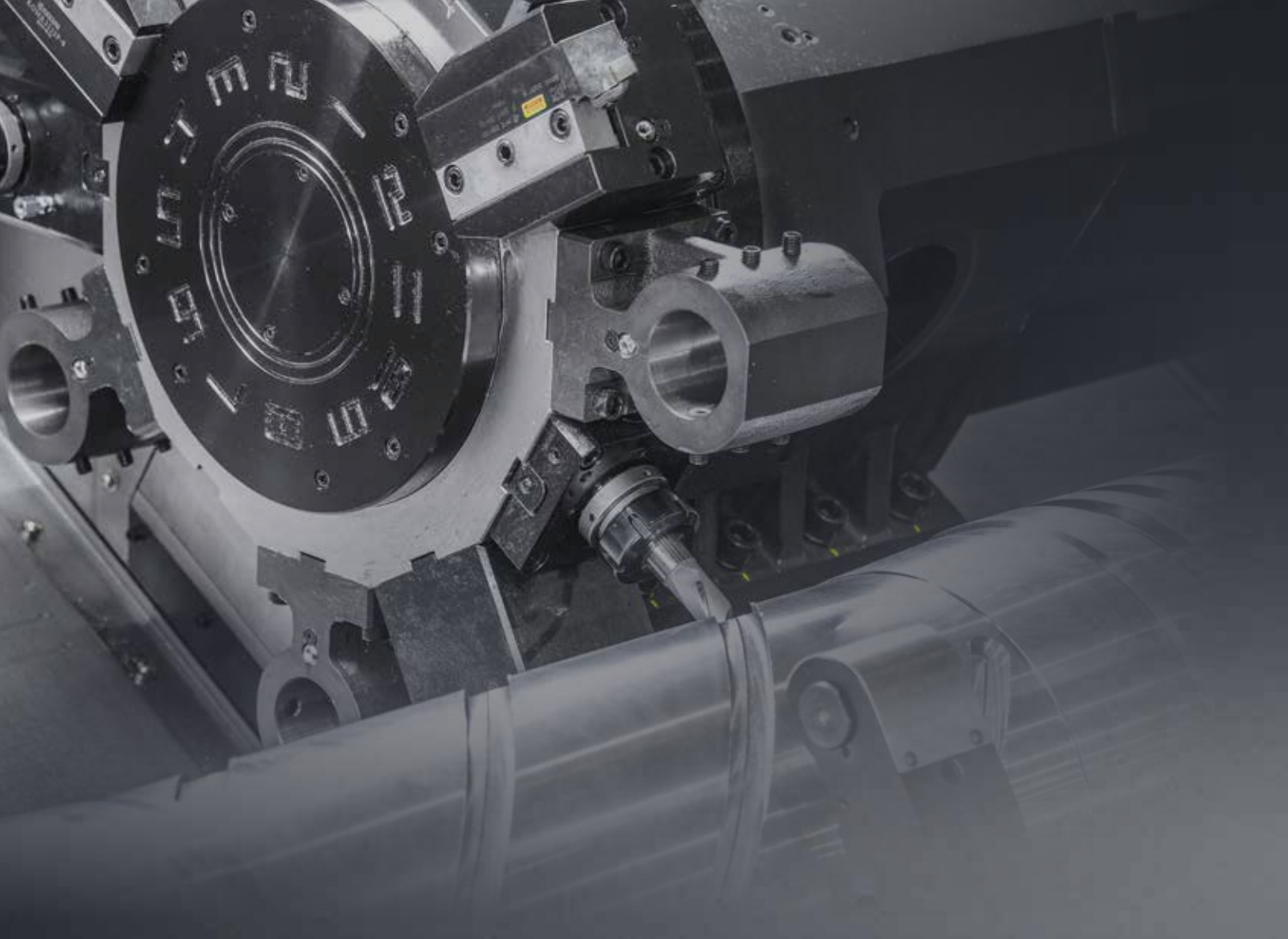

# Technical Leader

The CNC Turning Center L5100L Series designed by Hyundai WIA with years of expertise and the latest technology, is a Turning Center that maximizes productivity and performance.

ITEM	Chuck		Turret			Y-AXIS
	21"	24"	10 Stations	12 Stations	Mill Turret	
L5100L	●	○	●	○		
L5100LM	●	○		●	●	
L5100LC		○	●	○		
L5100LMC		○		●	●	
L5100LY	●			●	●	●

● : Standard   ○ : Option

# L 5100L Series

Heavy-Duty Cutting and Large Work Capacity, CNC Turning Center

- Secures rigidity with box guideways for each shaft
- Max. turning length 2,070mm (81.5") long bed structure
- 2 step gear box type main spindle
- Application of high-performance main spindle (L5100LC/LMC : Max. torque 4,486 N·m)
- Stable long shaft turning with steady rest option
- Multi-tasking operation with wedge type Y-axis BMT75 turret (L5100LY)



**L5100LY**

# 01 BASIC STRUCTURE

High Rigidity Bed & Structure for Heavy Duty Cutting CNC Turning Center

### High Precision Spindle

- L5100L/LM/Y : 1,500 r/min
- L5100LC/LMC : 1,000 r/min
- C-Axis Control : 0.001°

### Turret for Heavy Duty Cutting

- Turret Type : BMT75
- Mill Turret : 4,000 rpm (M/Y Type)

### 2 Step Gear Box

### Live Tail Stock

- Taper : MT#6
- Quill Travel : 120 mm (4.7")

### Improved Saddle Rigidity

Rigidity has increased by 23% compared to the previous model by increasing the area of contact between the saddle and the column.

#### ● Increased Marginal Cutting

L500LMA	1,080 cc	
L5100LY	1,392 cc	23% Increased





# HEAVY CUTTING AND HIGH-PRECISION MACHINING

## GUIDEWAY

### Box Guideway

The L5100L series, specialized in machining large products, features box guideways in all axis and gear driven main spindle.

Box Guideways show great performance in offsetting vibrations caused by heavy duty cutting.



**Rapid Traverse Rate (X/Z)** **20/18** m/min

### Travel (X/Z)

L5100L/LC	L5100LM/LMC	L5100LY
<b>400/2,255</b> mm	<b>400/2,170</b> mm	<b>360/2,120</b> mm
(15.7"/ 88.8")	(15.7"/ 85.4")	(14.2"/ 83.5")

## Y-AXIS MACHINING (L5100LY)

### Wedge Type Y-axis Structure

Designed with a compensating Y-axis structure that is fed by the simultaneous operation of the YS-axis and the X-axis, L5100LY features a tool rest of superior rigidity which demonstrates excellent performance for heavy-duty product machining.

In particular, off-center machining is available, which is not possible with general lathes, so that high added value products can be manufactured without additional post-processing.

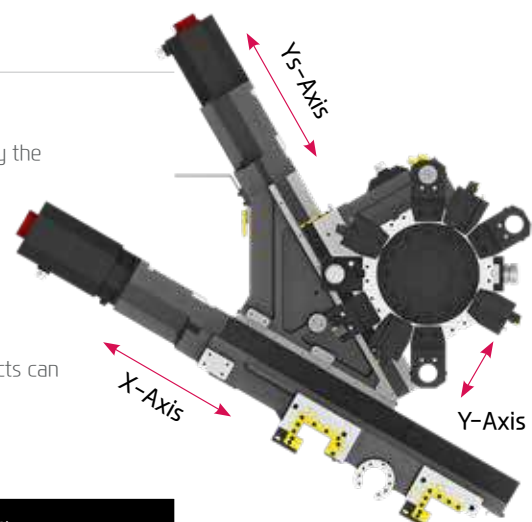

**Y-axis Rapid Traverse Rate** **12** m/min     **Y-axis Travel** **150** mm (5.9")

# 02 HIGH PRECISION SPINDLE

Long Lasting, High Accuracy & Excellent Performance CNC Turning Center

## Spindle Specifications

[ ] : Option

MODEL	Chuck Size	Speed	Motor (Max./Cont.)	Torque (Max./Cont.)	Driving Method
L5100L	21" [24"]	1,500 rpm	45/37 kW (60/50 HP)	4,112/3,382 N·m (3,032.9/2,494.4 lbf.ft)	Belt + 2 Step Gear
L5100LM/LY	21" [24"]/ 21"	1,500 rpm	45/37 kW (60/50 HP)	2,990/2,459 N·m (2,205.3/1,811.5 lbf.ft)	
L5100LC/LMC	[24"]	1,000 rpm	45/37 kW (60/50 HP)	4,486/3,689 N·m (3,308.7/2,720.9 lbf.ft)	

## BIG BORE SPINDLE (L5100LC/LMC)

Max. Spindle Bore  $\varnothing 276$  ( $\varnothing 10.9"$ ) show excellent performance in machining large cylindrical parts for oil and gas industry.

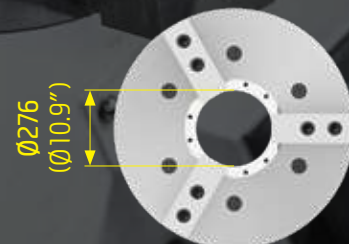

# HEAVY DUTY CUTTING & HIGH ACCURACY

## MAIN SPINDLE

### Spindle Ideal for Heavy Cutting

The combination of double cylindrical roller bearings and angular bearings leads to stable machining in heavy duty machining conditions.

Assembly units are finely polished to maintain high precision machining for a long period of time.

#### 2 Step Gear Box

A two-step driving method is applied inside the main spindle as standard on non mill turrets. It provides powerful torque at low speeds and stable rotation at high speeds.

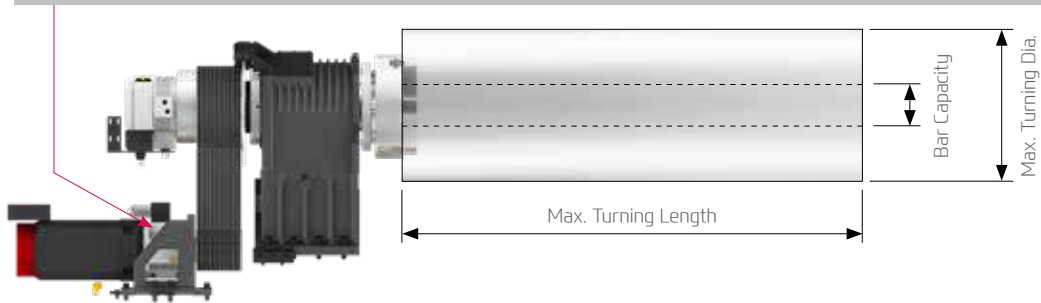

Model	Max. Turning Length	Max. Turning Dia.	Bar Capacity
L5100L/LC	2,205 mm (86.8")	Ø760 (Ø29.9") [Ø630 (Ø24.8")] mm	L5100L/LM/LY Ø165 mm (Ø6.5")
L5100LM/LMC	2,120 mm (83.5")	Ø680 mm (Ø26.8")	L5100LC/LMC Ø275 mm (Ø10.8")
L5100LY	2,100 mm (82.7")	Ø610 mm (Ø24")	

### C-Axis Control

C-axis of L5000 Series can be controlled to 0.001° which makes it possible to process various shapes.





# 03 SERVO TURRET

High speed, High Accuracy, Highly Reliable Servo Turret

## Standard Turret (L5100L/LC)

[ ] : Option

No. of Tools	Tool Size (O.D/I.D)	Indexing Time
10 [12] <small>EA</small>	□ 32/Ø60 <small>mm</small> (Ø1 1/4"/Ø2 1/4")	0.25 <small>sec</small>

## Mill Turret (L5100LM/LMC/LY)

Type	Speed	Motor (Max./Cont)	Torque (Max./Cont)	Collet Size
BMT75	4,000 rpm	23/7.5 kW (31/10 HP)	146/48 N·m (107.7/35.4 lbf.ft)	ER40-Ø26 (1")



# VARIOUS DRIVEN PRECISION BMT TOOL HOLDERS

## SERVO TURRET



### Standard Turret

The turret of L5100L series is applied with high performance AC servo motor, improving machining reliability. 3-piece coupling shows excellent performance in indexing.

Powerful hydraulic tool clamping minimizes tool tip deviation caused by load.

## BMT75 Mill Turret

The BMT turret secures the tool with four bolts and key on the tool mounting surface of the turret, making it possible to powerfully fix the tool, ensuring high reliability in rigidity and precision.

STRAIGHT MILLING HEAD



ANGULAR MILLING HEAD



### Mill Tool Holder

Machining capability has increased with the addition of straight milling head tool holder.

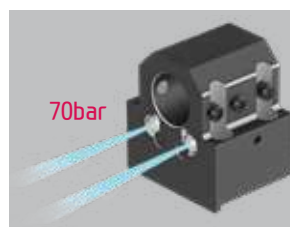

### 70Bar High Pressure Coolant **OPTION**

Turret is designed to utilize **70bar** high pressure coolant and it shows optimum performance in machining difficult-to-cut material.

# 04 USER CONVENIENCE

Various Devices for User Friendly

## TAIL STOCK & STEADY REST

### High-performance Tail Stock

Tailstock enables stable machining of high quality products where quill travels up to 120mm (4.7").  
(MT#5 Built-in Tail Stock : Option)

Taper	Quill Dia.	Quill Travel
Live : MT#6	Ø120 mm (Ø4.7")	120 mm (4.7")



### Steady Rest **OPTION**

You can easily adjust the position of the steady rest according to the shape of the product in a programmable way. In addition, for machining large workpieces, steady rest up to SLU X5.1 (Ø380) can be applied.

Steady Rest	SLU X5.1	SLU X5	SLU X4
Max. Size	Ø350 mm (Ø13.8")	Ø310 mm (Ø12.2")	Ø245 mm (Ø9.6")
Min. Size	Ø85 mm (Ø3.3")	Ø45 mm (Ø1.8")	Ø30 mm (Ø1.2")

❖ Please consult a sales manager for applicability of other types of steady rests.

## HIGH PRECISION SYSTEM



### Automatic Q-Setter

Quick and accurate tool calibration can be done by contacting the tool tip with the sensor.



### Linear Scale

Linear scales increase positioning accuracy and reduce distortion caused by thermal growth, thus ensuring a more accurate finished part

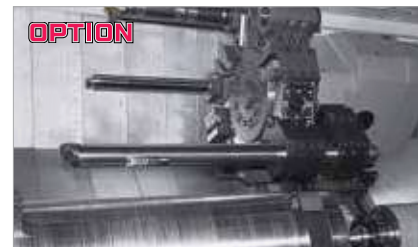

### Long Boring Tool holder

When using long boring tool holder, deeper inner diameter machining is possible, enabling faster and more precise machining.

Optional

## COOLANT UNIT



Standard Coolant (Nozzle)



Chuck Coolant (Upper Chuck)



Chuck Air Blow (Upper Chuck)



Gun Coolant

## CHIP DISPOSAL SOLUTION

### Chip Conveyor

Timely and effective disposal of chips will enhance productivity as well as the working environment.



Hinge	Chip Type : Roughing Chip, Long Chip, Chip complex	Material : SS41, 45C, Cast Steel	Front-Right Direction
	Highly efficient when disposing a lot of chips. Capable of handling stringy chips..		
Scraper	Chip Type : Finely broken chip blown out	Material : cast Iron, Nonferrous	
	Convenient for shortly cut chips.		
❖ Drum Filter	Chip Type : Powder, Micro Chip	Material : AL	
	Advantageous in precision, as the chips do not flow in to the coolant nozzle.		

❖ When ordering a drum filter chip conveyor, prior consult with hyundai wia's sales person.

# 05 HYUNDAI WIA FANUC – Smart Plus

The Compatible All-round Control



15" Touch-type Monitor as a standard

Fast Cycle Time Technology	Smart Machine Control	Fine Surface Technology
Smart Servo Control Technology	Conversational Program	SmartGuide-i
Machining-aid Function	i-HMI	5120M (2MB)
1000 EA	Part Program Storage	No. of Registerable Programs

## Servo Learning Oscillation Function for Chip Breaking **OPTION**

- Machining Method : he tool cuts the workpiece moving in a zigzag pattern. (Oscillating) → Air cut section occurs → Long chips break
- Advantage : Increase tool life, Enhance surface finishing, Improve chip disposal
- Machine : All turning centers with FANUC controller (Option)

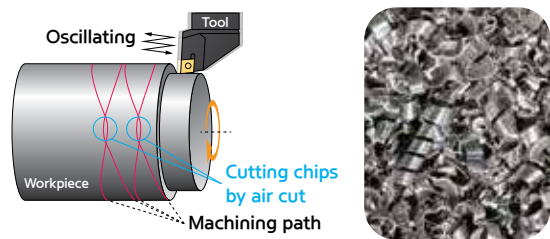

(Developed special screen page for servo learning oscillation function / Even when this function is applied, the cycle time remains same.)



## MMS (Machine Monitoring System)



### MMS Cloud

A cloud server-based equipment monitoring system for collecting and analyzing facility operation data.

Manufacturing big data solution with design, manufacturing, and intelligence technology of HYUNDAI-WIA  
(Big data collection/Analysis/Visualization)

## SMART CNC (FANUC Smart Plus)



### 1. Dialogue Program (Smart Guide-i)

This software offers the maximum user convenience through dialogue manipulation from setup to processing. This includes writing processing programs and simulation checks.

### 2. LAUNCHER

This software offers shortcuts for quick access to specialized features and frequently used features.

# SPECIFICATIONS

## Standard & Optional

● : Standard ○ : Option ☆ : Prior Consultation - : Non Applicable

Spindle		L5100L	L5100LM
Main Spindle	21"	●	●
Hollow Chuck 3 Jaw	24"	○	○
Main Spindle	21"	☆	☆
Solid Chuck 3 Jaw	24"	☆	☆
Standard Soft Jaw (1set)		●	●
Chuck Clamp Foot Switch		●	●
2 Steps Hyd. Pressure Device		○	○
Spindle Inside Stopper		☆	☆
C-axis (0.001")		●	●
Cs contouring function		-	☆
Chuck Open/Close Confirmation Device		●	●
2 Steps Chuck Foot Switch		○	○
Turret			
Tool Holder		●	●
10 station Turret		●	-
12 station Turret		○	●
Mill Turret	BMT	-	●
Straight Milling Head	Collet Type,lea	-	●
Angular Milling Head	Collet Type,lea	-	●
Straight Milling Head	Adapter Type	-	-
Angular Milling Head	Adapter Type	-	-
Boring Sleeve		●	●
Drill Socket		○	○
U-Drill Holder		○	○
U-Drill Holder	CAP (1EA)	○	○
Extension Holder	For Out-Dia	●	-
Angle Head		-	☆
Tail Stock & Steady Rest			
Live-center Tail Stock (MT #6)		●	●
Built-in Tail Stock (MT #5)		○	○
Manual Type Steady Rest		☆	☆
Manual Hyd. Steady Rest		☆	☆
Programmable Hyd. Steady Rest (SLU X 5.1)		○	○
2 Steps Tail Stock Pressure System		☆	☆
Quill Forward/Reverse Confirmation Device		●	●
Tail Stock Foot Switch (When Tail Stock is selected)		●	●
Coolant & Air Blow			
Standard Coolant (Nozzle)		●	●
Chuck Coolant (Upper Chuck)		☆	☆
Gun Coolant		○	○
Through Spindle Coolant (Only for Special Chuck)		☆	☆
Chuck Air Blow (Upper Chuck)		○	○
Tail Stock Air Blow (Upper Tail Stock)		☆	☆
Turret Air Blow		☆	☆
Air Gun		○	○
Through Spindle Air Blow (Only for Special Chuck)		☆	☆
High Pressure Coolant	6Bar 20Bar 70Bar	● ○ ○	● ○ ○
Power Coolant System (For Automation)		☆	☆
Coolant Chiller		☆	☆
Chip Disposal			
Coolant Tank	500 ℓ (132.1 gal)	●	●
Chip Conveyor (Hinge/Scraper)	Front (Right) Front (Rear)	○ -	○ -
Special Chip Conveyor (Drum Filter)		☆	☆
Chip Wagon	Standard 180 ℓ (47.5 gal)	○	○
	Swing 200 ℓ (52.8 gal)	○	○
	Large Swing 290 ℓ (76.6 gal)	○	○
	Large Size 330 ℓ (87.2 gal)	○	○
	Customized	☆	☆

Safety Device		L5100L	L5100LM
Total Splash Guard		●	●
Chuck Hydraulic Pressure Maintenance Interlock		☆	☆
Electric Device			
Call Light	1Color : ●	●	●
Call Light & Buzzer	3Color : ● ● ● B	○	○
Electric Cabinet Light		○	○
Remote MPG		○	○
Workcounter	Digital	○	○
Totalcounter	Digital	○	○
Toolcounter	Digital	○	○
Multi-Tool counter	Digital	○	○
Electric Circuit Breaker		○	○
AVR (Auto Voltage Regulator)		☆	☆
Transformer	60kVA	○	○
Auto Power Off		○	○
Measurement			
Q-Setter	Manual Automatic	☆ ○	☆ ○
Work Close Confirmation Device (Only for Special Chuck)	TACO SMC	☆ ☆	☆ ☆
Work Setter		☆	☆
Linear Scale	X-Axis	○	○
	Z-Axis	○	○
	Y-Axis	-	-
Coolant Level Sensor (Only for Chip Conveyor)		☆	☆
Environment			
Air Conditioner		○	○
Oil Mist Collector		☆	☆
Oil Skimmer (Only for Chip Conveyor)		○	○
MQL (Minimal Quantity Lubrication)		☆	☆
Fixture & Automation			
Auto Door		○	○
Auto Shutter (Only for Automatic System)		-	-
Sub Operation Pannel		☆	☆
Bar Feeder Interface		○	○
Bar Feeder		☆	☆
Extra M-Code 4ea		○	○
Automation interface		☆	☆
I/O Extension (IN & OUT)	16 Contact 32 Contact	○ ○	○ ○
Parts Catcher		-	-
Turret Work Pusher (For Automation)		☆	☆
Hyd. Device			
Standard Hyd. Cylinder	Hollow	●	●
Standard Hyd. Unit	60bar/45 ℓ (11.9 gal)	●	●
S/W			
Dialogue Program (HW-DPRO)		○	○
DNC software (HW-eDNC)		○	○
Machine Monitoring System (HW-MMS Cloud)		☆	☆
Smart Guide-1 : FANUC		●	●
Smart S/W		☆	☆
ETC			
Tool Box		●	●
Customized Color	Need Munsell No.	☆	☆
CAD & CAM		☆	☆

❖ Thermal Displacement Compensation device is recommended, when more than 6 bar of high pressure coolant is applied, for the high quality machining.

Specifications are subject to change without notice for improvement. / Please refer to the S/W catalog (iRIS) for details by S/W product.

# SPECIFICATIONS

## Standard & Optional

● : Standard ○ : Option ☆ : Prior Consultation - : Non Applicable

Spindle		L5100LC	L5100LMC
Main Spindle	21"	-	-
Hollow Chuck 3 Jaw	24"	☆	☆
Main Spindle	21"	-	-
Solid Chuck 3 Jaw	24"	☆	☆
Standard Soft Jaw (1set)		●	●
Chuck Clamp Foot Switch		●	●
2 Steps Hyd. Pressure Device		○	○
Spindle Inside Stopper		☆	☆
C-axis (0.001")		●	●
Cs contouring function		-	☆
Chuck Open/Close Confirmation Device		●	●
2 Steps Chuck Foot Switch		○	○
<b>Turret</b>			
Tool Holder		●	●
10 station Turret		●	-
12 station Turret		○	●
Mill Turret	BMT	-	●
Straight Milling Head	Collet Type, 1ea	-	●
Angular Milling Head	Collet Type, 1ea	-	●
Straight Milling Head	Adapter Type	-	-
Angular Milling Head	Adapter Type	-	-
Boring Sleeve		●	●
Drill Socket		○	○
U-Drill Holder		○	○
U-Drill Holder	CAP (1EA)	○	○
Extension Holder	For Out-Dia	●	-
Angle Head		-	☆
<b>Tail Stock &amp; Steady Rest</b>			
Live-center Tail Stock (MT #6)		●	●
Built-in Tail Stock (MT #5)		○	○
Manual Type Steady Rest		☆	☆
Manual Hyd. Steady Rest		☆	☆
Programmable Hyd. Steady Rest (SLU X 5.1)		○	○
2 Steps Tail Stock Pressure System		☆	☆
Quill Forward/Reverse Confirmation Device		●	●
Tail Stock Foot Switch (When Tail Stock is selected)		●	●
<b>Coolant &amp; Air Blow</b>			
Standard Coolant (Nozzle)		●	●
Chuck Coolant (Upper Chuck)		☆	☆
Gun Coolant		○	○
Through Spindle Coolant (Only for Special Chuck)		☆	☆
Chuck Air Blow (Upper Chuck)		○	○
Tail Stock Air Blow (Upper Tail Stock)		☆	☆
Turret Air Blow		☆	☆
Air Gun		○	○
Through Spindle Air Blow (Only for Special Chuck)		☆	☆
High Pressure Coolant	6Bar	●	●
	20Bar	○	○
	70Bar	○	○
Power Coolant System (For Automation)		☆	☆
Coolant Chiller		☆	☆
<b>Chip Disposal</b>			
Coolant Tank	500 ℓ (132.1 gal)	●	●
Chip Conveyor (Hinge/Scraper)	Front (Right)	○	○
	Front (Rear)	-	-
Special Chip Conveyor (Drum Filter)		☆	☆
Chip Wagon	Standard 180 ℓ (47.5 gal)	○	○
	Swing 200 ℓ (52.8 gal)	○	○
	Large Swing 290 ℓ (76.6 gal)	○	○
	Large Size 330 ℓ (87.2 gal)	○	○
	Customized	☆	☆

Safety Device		L5100LC	L5100LMC
Total Splash Guard		●	●
Chuck Hydraulic Pressure Maintenance Interlock		☆	☆
<b>Electric Device</b>			
Call Light	1Color : ●	●	●
Call Light & Buzzer	3Color : ● ■ ■ B	○	○
Electric Cabinet Light		○	○
Remote MPG		○	○
Workcounter	Digital	○	○
Totalcounter	Digital	○	○
Toolcounter	Digital	○	○
Multi-Tool counter	Digital	○	○
Electric Circuit Breaker		○	○
AVR (Auto Voltage Regulator)		☆	☆
Transformer	60kVA	○	○
Auto Power Off		○	○
<b>Measurement</b>			
Q-Setter	Manual	☆	☆
	Automatic	○	○
Work Close Confirmation Device (Only for Special Chuck)	TACO	☆	☆
	SMC	☆	☆
Work Setter		☆	☆
Linear Scale	X-Axis	○	○
	Z-Axis	○	○
	Y-Axis	-	-
Coolant Level Sensor (Only for Chip Conveyor)		☆	☆
<b>Environment</b>			
Air Conditioner		○	○
Oil Mist Collector		☆	☆
Oil Skimmer (Only for Chip Conveyor)		○	○
MQL (Minimal Quantity Lubrication)		☆	☆
<b>Fixture &amp; Automation</b>			
Auto Door		○	○
Auto Shutter (Only for Automatic System)		-	-
Sub Operation Pannel		☆	☆
Bar Feeder Interface		○	○
Bar Feeder		☆	☆
Extra M-Code 4ea		○	○
Automation Interface		☆	☆
I/O Extension (IN & OUT)	16 Contact	○	○
	32 Contact	○	○
Parts Catcher		-	-
Turret Work Pusher (For Automation)		☆	☆
<b>Hyd. Device</b>			
Standard Hyd. Cylinder	Hollow	●	●
Standard Hyd. Unit	60bar/45 ℓ (11.9 gal)	●	●
<b>S/W</b>			
Dialogue Program (HW-DPRO)		○	○
DNC software (HW-eDNC)		○	○
Machine Monitoring System (HW-MMS Cloud)		☆	☆
Smart Guide-i : FANUC		●	●
Smart S/W		☆	☆
<b>ETC</b>			
Tool Box		●	●
Customized Color	Need Munsell No.	☆	☆
CAD & CAM		☆	☆

❖ Thermal Displacement Compensation device is recommended, when more than 6 bar of high pressure coolant is applied, for the high quality machining.

Specifications are subject to change without notice for improvement. / Please refer to the S/W catalog (IRIS) for details by S/W product.

# SPECIFICATIONS

## Standard & Optional

● : Standard ○ : Option ☆ : Prior Consultation - : Non Applicable

Spindle		L5100LY
Main Spindle	21"	●
Hollow Chuck 3 Jaw	24"	-
Main Spindle	21"	☆
Solid Chuck 3 Jaw	24"	-
Standard Soft Jaw (1set)		●
Chuck Clamp Foot Switch		●
2 Steps Hyd. Pressure Device		○
Spindle Inside Stopper		☆
C-axis (0.001")		●
Cs contouring function		☆
Chuck Open/Close Confirmation Device		●
2 Steps Chuck Foot Switch		○
Turret		
Tool Holder		●
10 station Turret		-
12 station Turret		●
Mill Turret	BMT	●
Straight Milling Head	Collet Type,lea	●
Angular Milling Head	Collet Type,lea	●
Straight Milling Head	Adapter Type	-
Angular Milling Head	Adapter Type	-
Boring Sleeve		●
Drill Socket		○
U-Drill Holder		○
U-Drill Holder	CAP (1EA)	○
Extension Holder	For Out-Dia	-
Angle Head		☆
Tail Stock & Steady Rest		
Live-center Tail Stock (MT #6)		●
Built-in Tail Stock (MT #5)		○
Manual Type Steady Rest		☆
Manual Hyd. Steady Rest		☆
Programmable Hyd. Steady Rest (SLU X 5.1)		○
2 Steps Tail Stock Pressure System		☆
Quill Forward/Reverse Confirmation Device		●
Tail Stock Foot Switch (When Tail Stock is selected)		●
Coolant & Air Blow		
Standard Coolant (Nozzle)		●
Chuck Coolant (Upper Chuck)		☆
Gun Coolant		○
Through Spindle Coolant (Only for Special Chuck)		☆
Chuck Air Blow (Upper Chuck)		○
Tail Stock Air Blow (Upper Tail Stock)		☆
Turret Air Blow		☆
Air Gun		○
Through Spindle Air Blow (Only for Special Chuck)		☆
High Pressure Coolant	6Bar	●
	20Bar	○
	70Bar	○
Power Coolant System (For Automation)		☆
Coolant Chiller		☆
Chip Disposal		
Coolant Tank	500 ℓ (132.1 gal)	●
Chip Conveyor (Hinge/Scraper)	Front (Right)	○
	Front (Rear)	-
Special Chip Conveyor (Drum Filter)		☆
Chip Wagon	Standard 180 ℓ (47.5 gal)	○
	Swing 200 ℓ (52.8 gal)	○
	Large Swing 290 ℓ (76.6 gal)	○
	Large Size 330 ℓ (87.2 gal)	○
	Customized	☆

Safety Device		L5100LY
Total Splash Guard		●
Chuck Hydraulic Pressure Maintenance Interlock		☆
Electric Device		
Call Light	1Color : ●	●
Call Light & Buzzer	3Color : ● ● ● B	○
Electric Cabinet Light		○
Remote MPG		○
Workcounter	Digital	○
Totalcounter	Digital	○
Toolcounter	Digital	○
Multi-Tool counter	Digital	○
Electric Circuit Breaker		○
AVR (Auto Voltage Regulator)		☆
Transformer	60kVA	○
Auto Power Off		○
Measurement		
Q-Setter	Manual	☆
	Automatic	○
Work Close Confirmation Device (Only for Special Chuck)	TACO	☆
	SMC	☆
Work Setter		☆
Linear Scale	X-Axis	○
	Z-Axis	○
	Y-Axis	○
Coolant Level Sensor (Only for Chip Conveyor)		☆
Environment		
Air Conditioner		○
Oil Mist Collector		☆
Oil Skimmer (Only for Chip Conveyor)		○
MLQ (Minimal Quantity Lubrication)		☆
Fixture & Automation		
Auto Door		○
Auto Shutter (Only for Automatic System)		-
Sub Operation Pannel		☆
Bar Feeder Interface		○
Bar Feeder		☆
Extra M-Code 4ea		○
Automation interface		☆
I/O Extension (IN & OUT)	16 Contact	○
	32 Contact	○
Parts Catcher		-
Turret Work Pusher (For Automation)		☆
Hyd. Device		
Standard Hyd. Cylinder	Hollow	●
Standard Hyd. Unit	60bar/45 ℓ (11.9 gal)	●
S/W		
Dialogue Program (HW-DPRO) : FANUC		○
DNC software (HW-eDNC)		○
Machine Monitoring System (HW-MMS Cloud)		☆
Smart Guide-I : FANUC		●
Smart S/W		☆
ETC		
Tool Box		●
Customized Color	Need Munsell No.	☆
CAD & CAM		☆

❖ 4 channel of TDC(Thermal Displacement Compensation) device is recommended, when more than 6 bar of high pressure coolant is applied, for the high quality machining.

Specifications are subject to change without notice for improvement. / Please refer to the S/W catalog (iRIS) for details by S/W product.



# SPECIFICATIONS

## Spindle Output/Torque Diagram

### L5100L 1,500 rpm

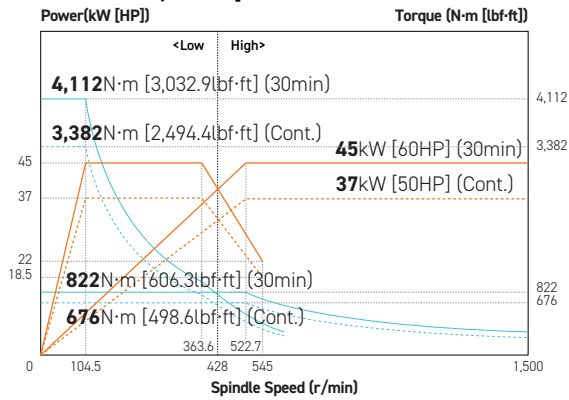

### L5100LM/LY 1,500 rpm

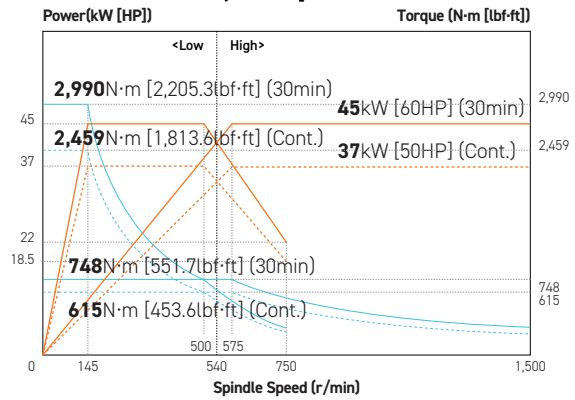

### L5100LC/LMC 1,000 rpm

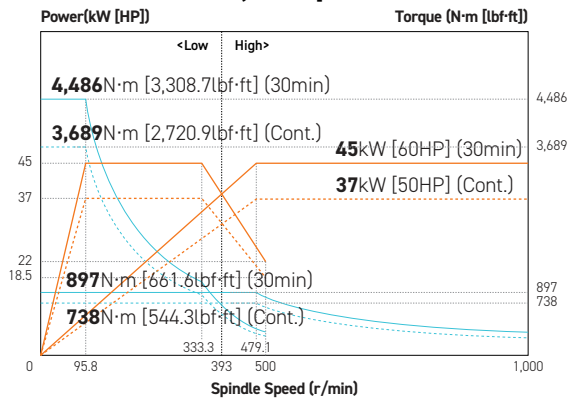

### Mill Spindle 4,000 rpm

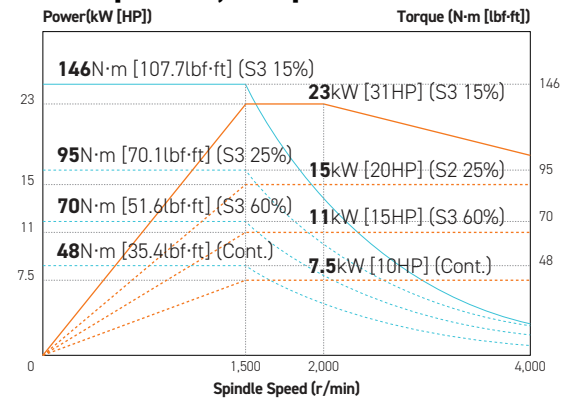

# SPECIFICATIONS

## External Dimensions

unit : mm(in)

### L5100L/LM

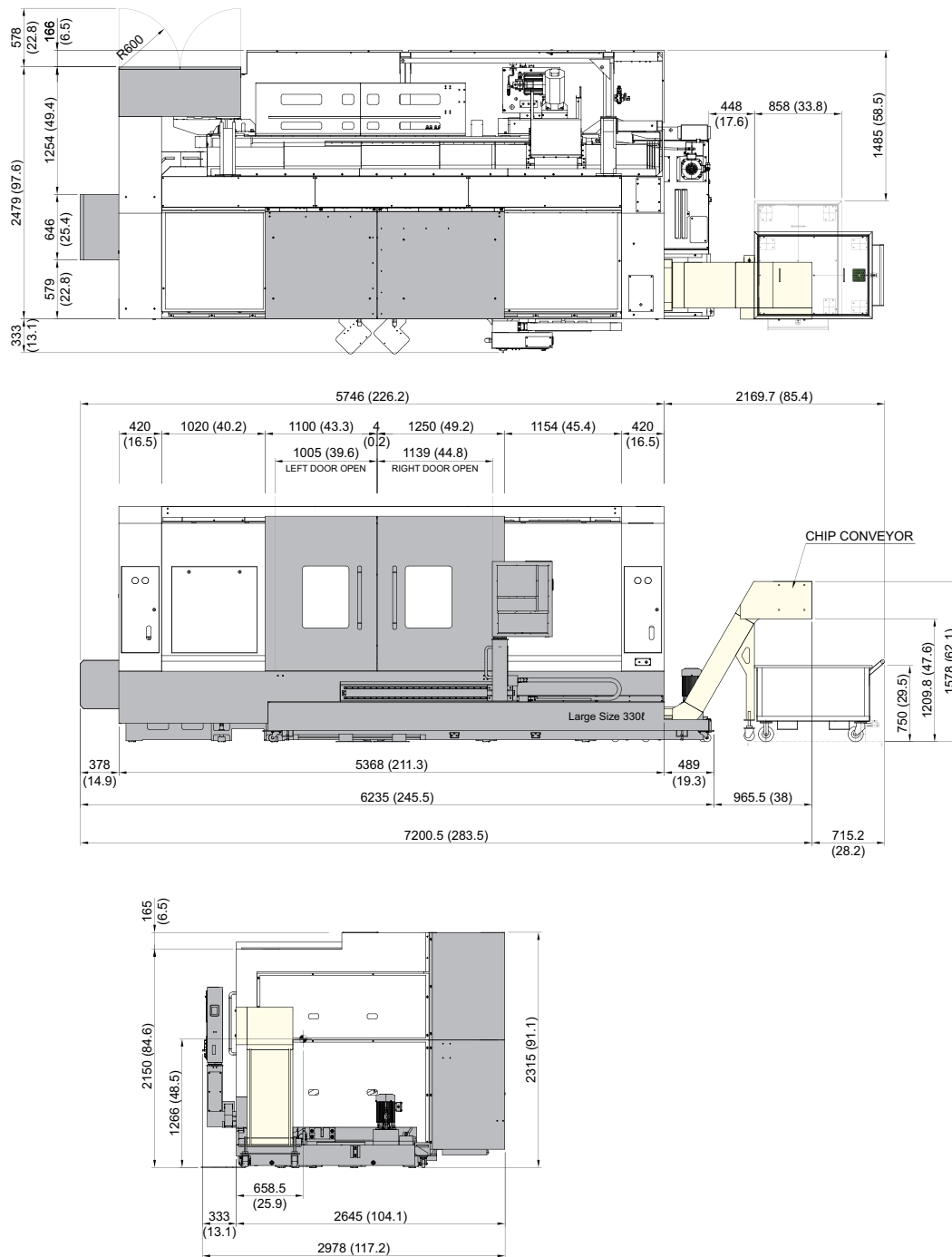

# SPECIFICATIONS

## External Dimensions

unit : mm(in)

### L5100LC/LMC

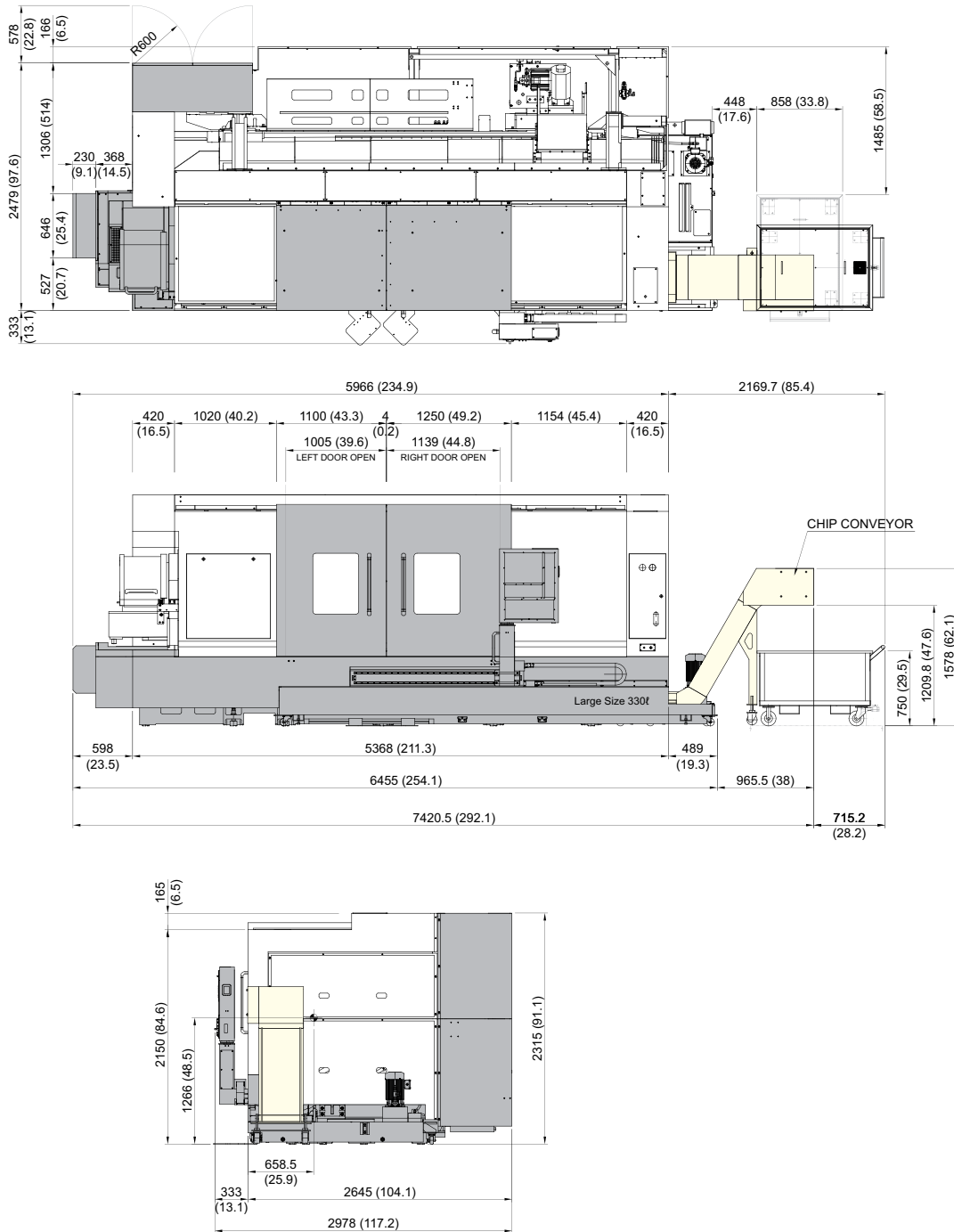

# SPECIFICATIONS

## External Dimensions

unit : mm(in)

### L5100LY

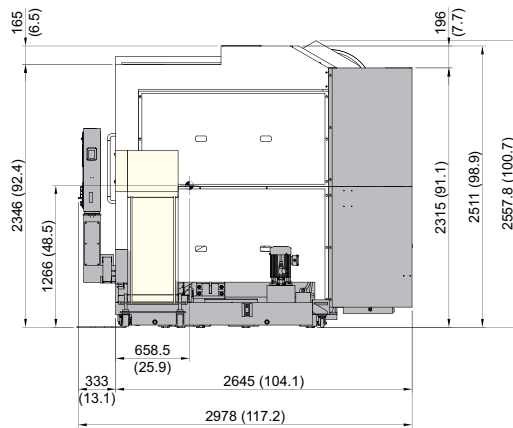
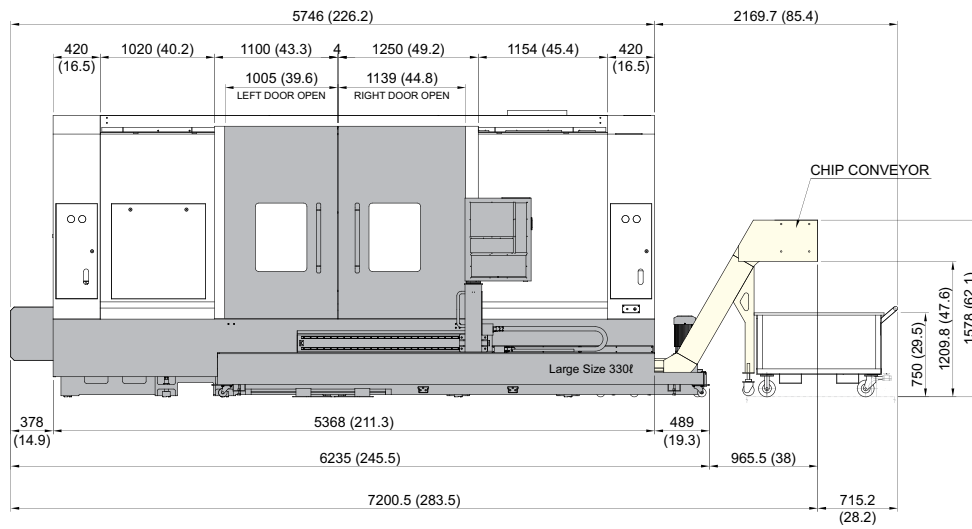
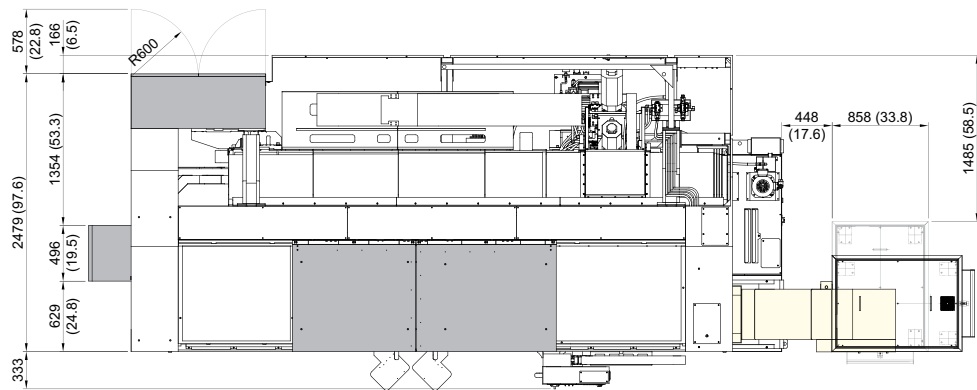

# SPECIFICATIONS

## Interference

unit : mm(in)

**L5100L/LC  
(10 Station)**

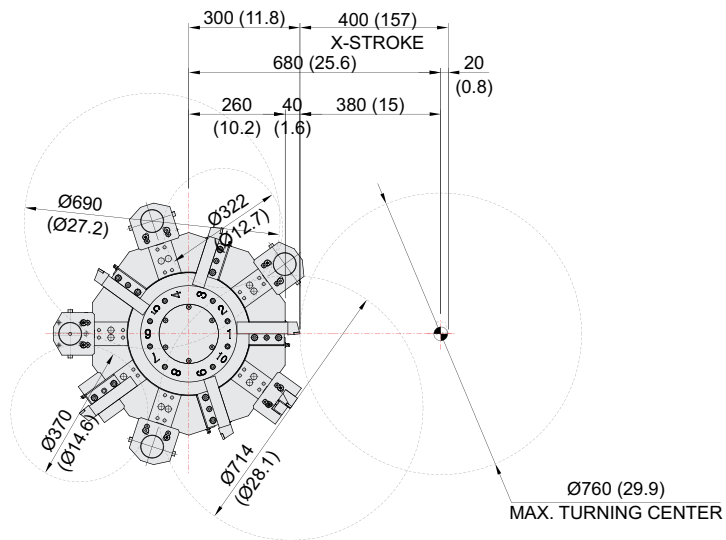

**L5100L/LC  
(12 Station)**

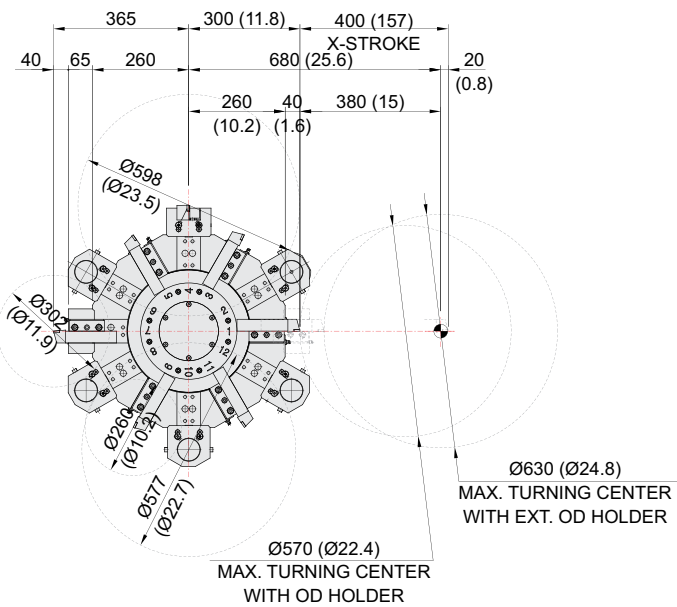



# SPECIFICATIONS

## Interference

unit : mm(in)

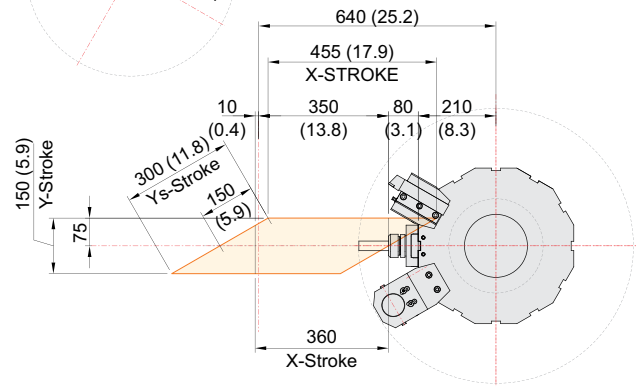
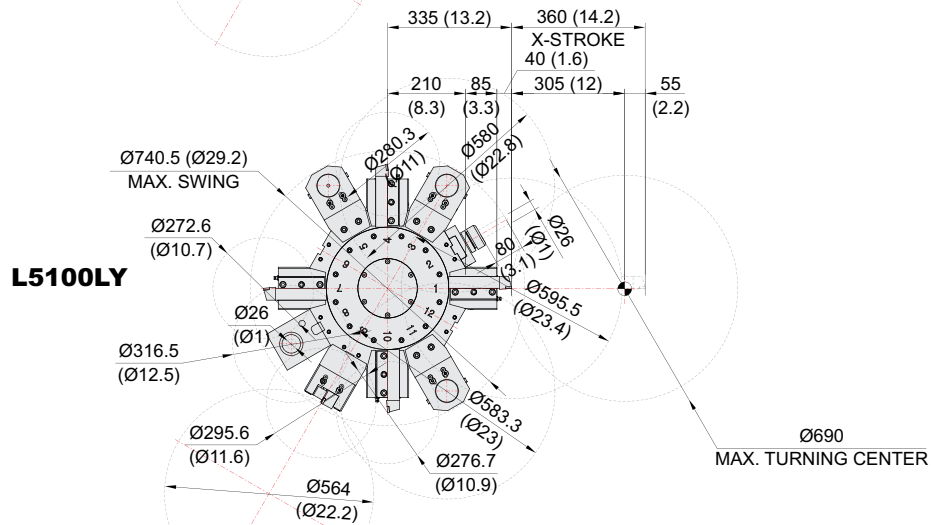
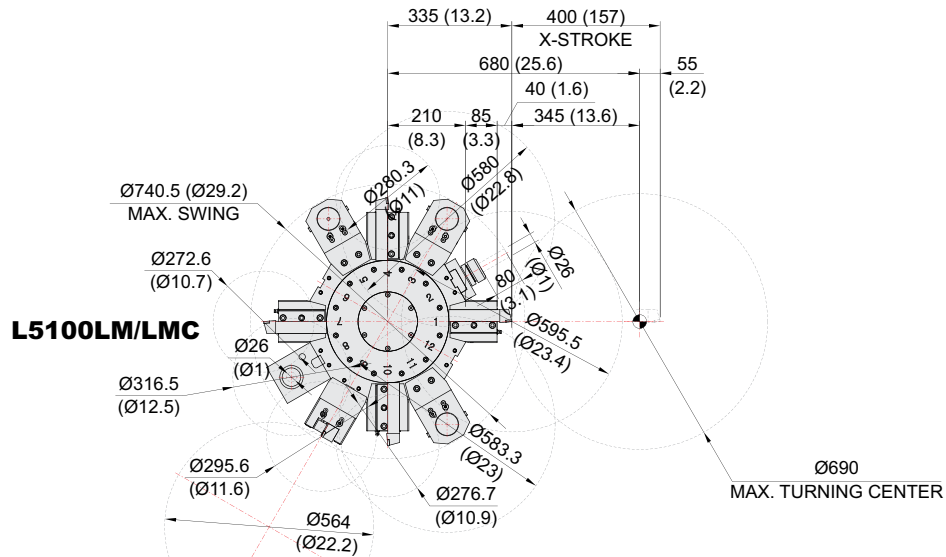

# SPECIFICATIONS

## Tooling System

unit : mm(in)

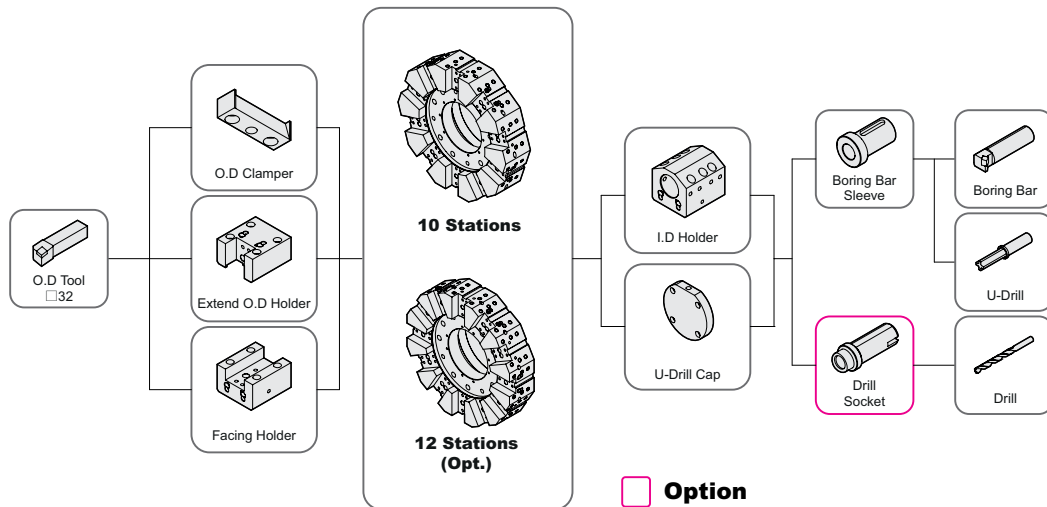

### L5100L/LC – Tooling Parts Detail

ITEM			10 Station		Opt. 12 Station	
			mm Unit	inch Unit	mm Unit	inch Unit
Turning Holder	O.D Holder	Right/Left	4	4	5	5
		Extension	1	1	1	1
	Facing Holder	1	1	1	1	
Boring Holder	I.D Holder	Single	4	4	5	5
		C-Clip	Opt.	Opt.	Opt.	Opt.
	U-Drill Holder	Cap	1	1	1	1
Driven Holder	Straight Mill Holder	Standard	-	-	-	-
	Angular Mill Holder	Standard	-	-	-	-
Socket	Boring	Ø16 (Ø5/8")	1	1	1	1
		Ø20 (Ø3/4")	1	1	1	1
		Ø25 (Ø1")	1	1	1	1
		Ø32 (Ø1 1/4")	1	1	1	1
		Ø40 (Ø1 1/2")	1	1	1	1
		Ø50 (Ø2")	1	1	1	1
	Drill	MT 2	Opt.	Opt.	Opt.	Opt.
		MT 3	Opt.	Opt.	Opt.	Opt.
		MT 4	Opt.	Opt.	Opt.	Opt.
	ER Collet		-	-	-	-
Adapter Set		-	-	-	-	

Specifications are subject to change without notice for improvement.

# SPECIFICATIONS

## Tooling System

unit : mm(in)

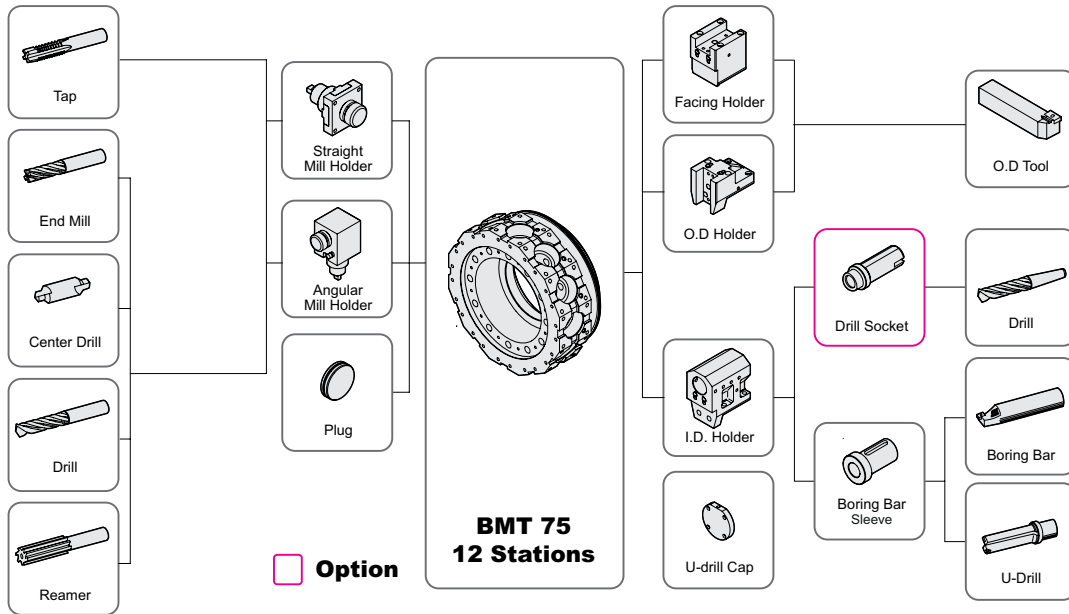

## L5100LM/LMC/LY – Tooling Parts Detail

ITEM			12 Station	
			mm Unit	inch Unit
Turning Holder	O.D Holder	Right/Left	4	4
		Extension	-	-
	Facing Holder		1	1
Boring Holder	I.D Holder	Single	3	3
		C-Clip	Opt.	Opt.
	U-Drill Holder	Cap	1	1
Driven Holder	Straight Mill Holder	Standard	1	1
	Angular Mill Holder	Standard	1	1
Socket	Boring	Ø16 (Ø5/8")	1	1
		Ø20 (Ø3/4")	1	1
		Ø25 (Ø1")	1	1
		Ø32 (Ø1 1/4")	1	1
		Ø40 (Ø1 1/2")	1	1
		Ø50 (Ø2")	1	1
	Drill	MT 2	Opt.	Opt.
		MT 3	Opt.	Opt.
		MT 4	Opt.	Opt.
	ER Collet		Opt.	Opt.
Adapter Set		-	-	

# SPECIFICATIONS

## Tooling Travel Range

unit : mm(in)

### L5100L/LC

#### O.D. HOLDER

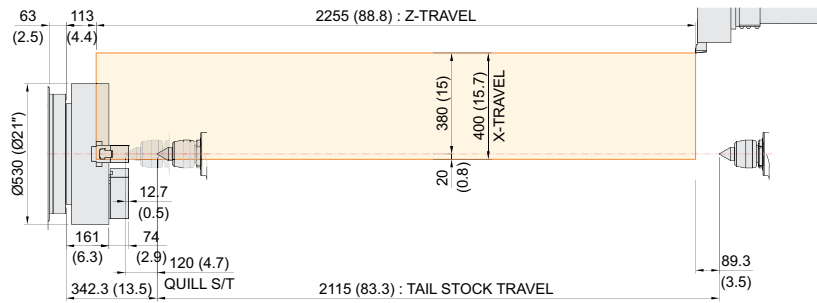

#### I.D. HOLDER

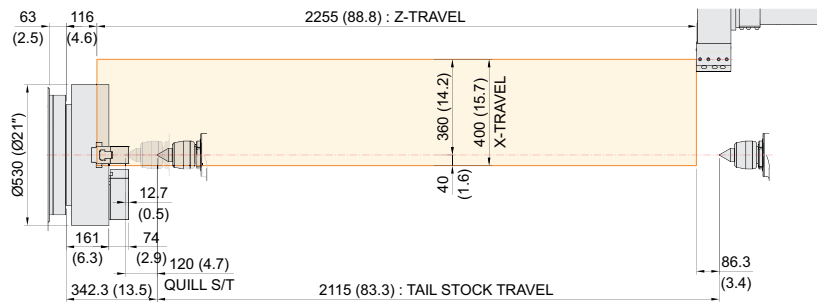

#### FACE HOLDER

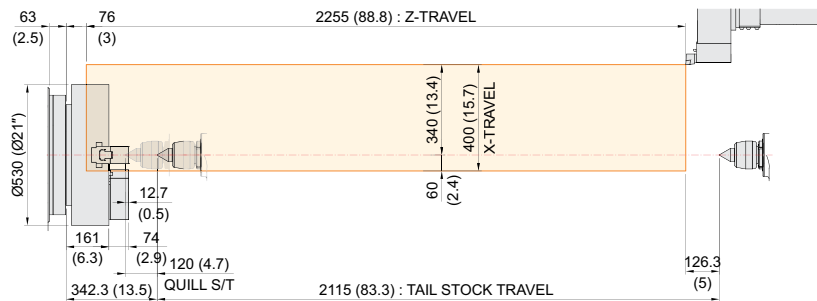

#### EXTENDED O.D.

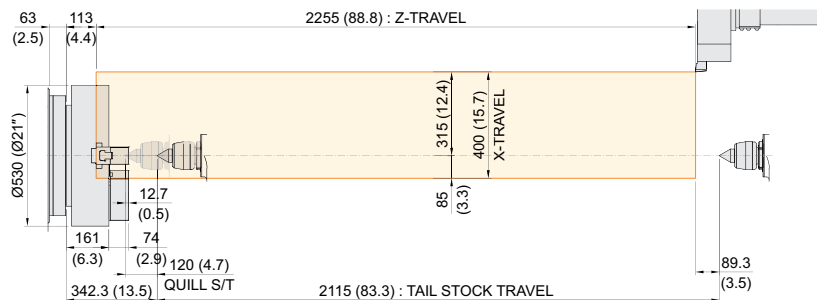

# SPECIFICATIONS

Tooling Travel Range

unit : mm

L5100LM/LMC

## O.D. HOLDER

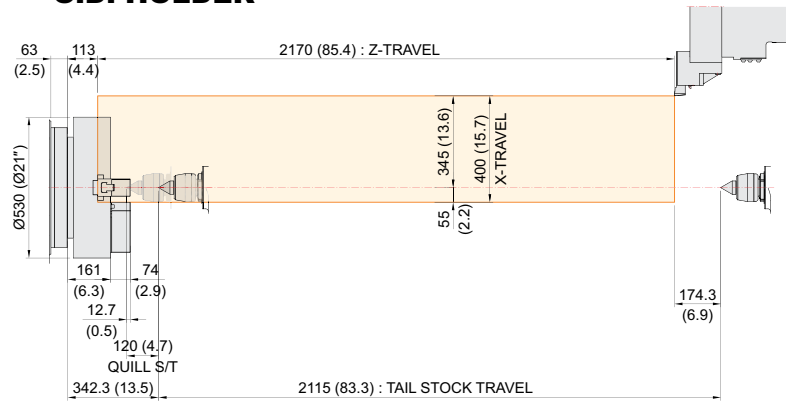

## I.D. HOLDER

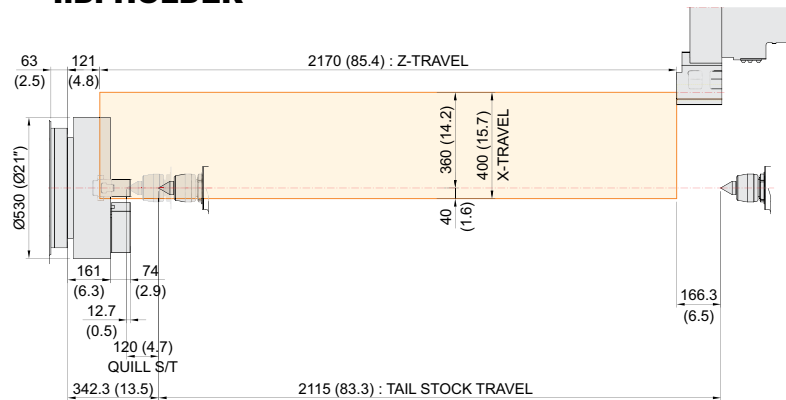

## FACE HOLDER

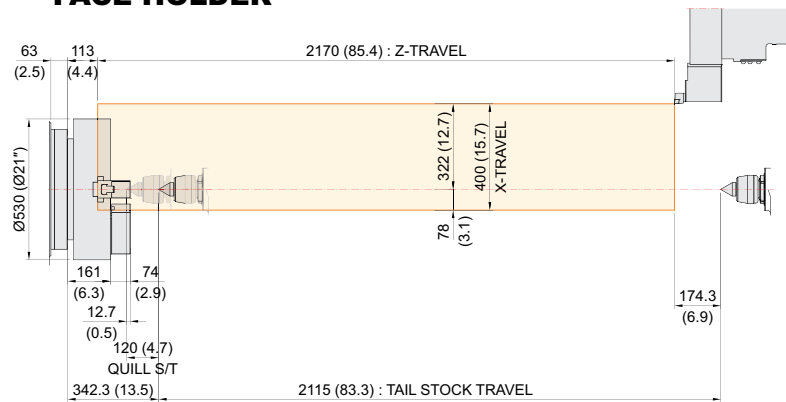



# SPECIFICATIONS

## Tooling Travel Range

unit : mm

### L5100LM/LMC

#### AXIAL DRIVEN

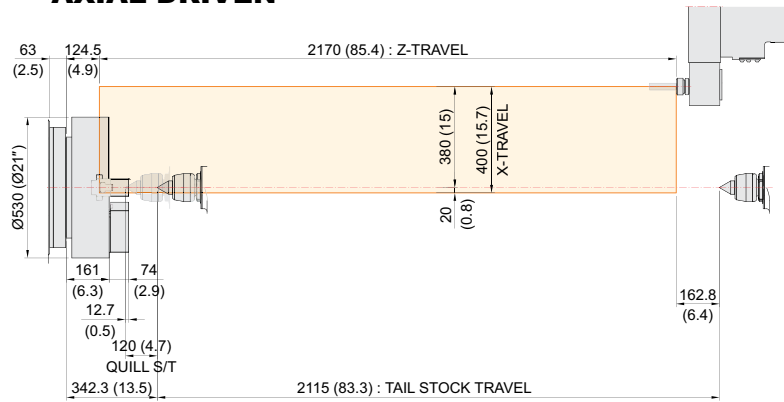

#### RADIAL DRIVEN

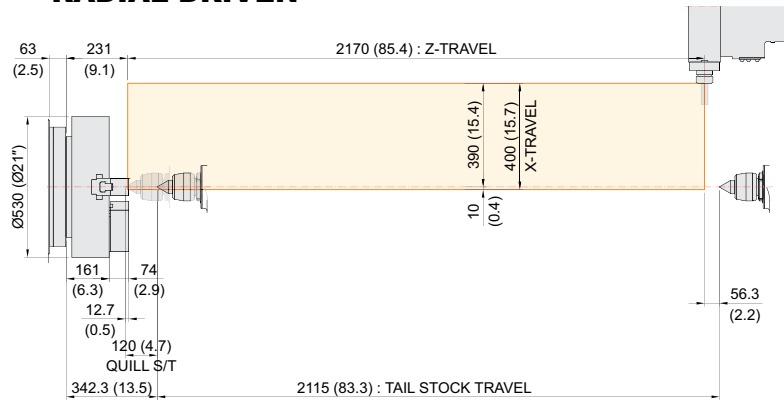

# SPECIFICATIONS

## Tooling Travel Range

unit : mm(in)

L5100LY

### O.D. HOLDER

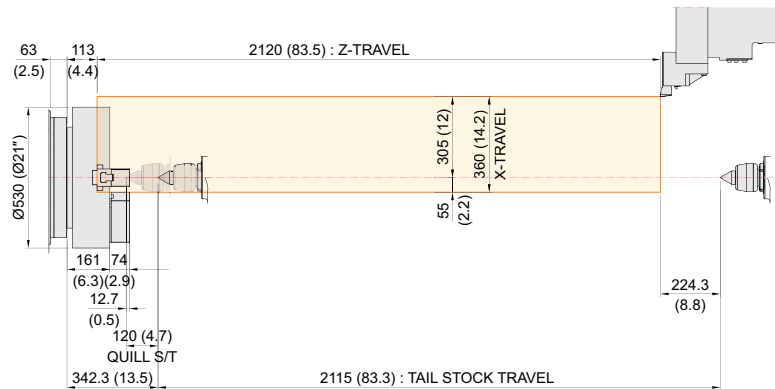

### I.D. HOLDER

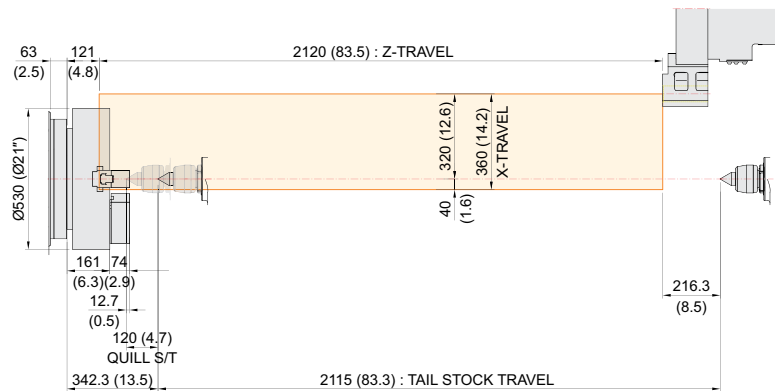

### FACE HOLDER

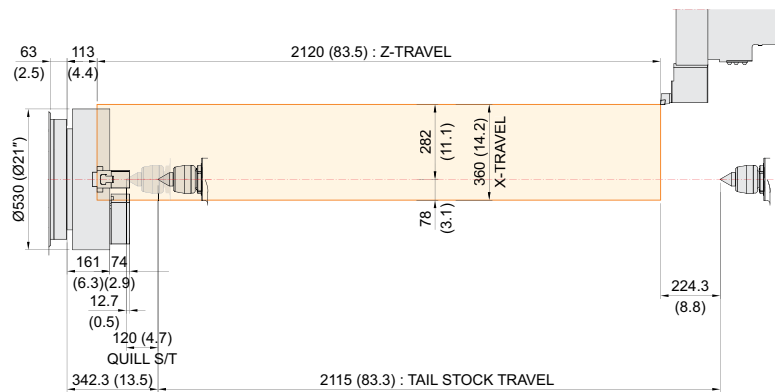

# SPECIFICATIONS

## Tooling Travel Range

unit : mm(in)

L5100LY

### AXIAL DRIVEN

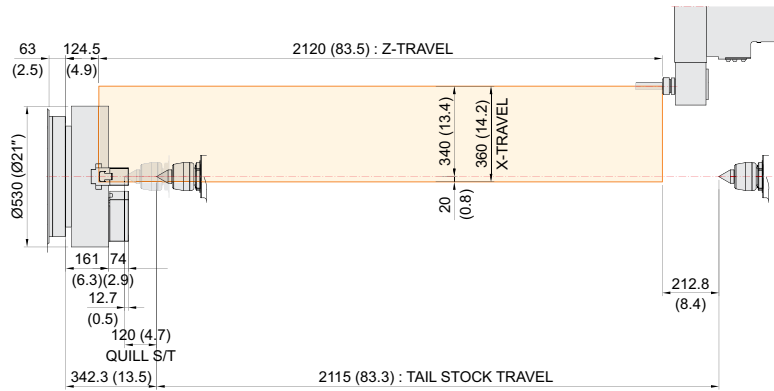

### RADIAL DRIVEN

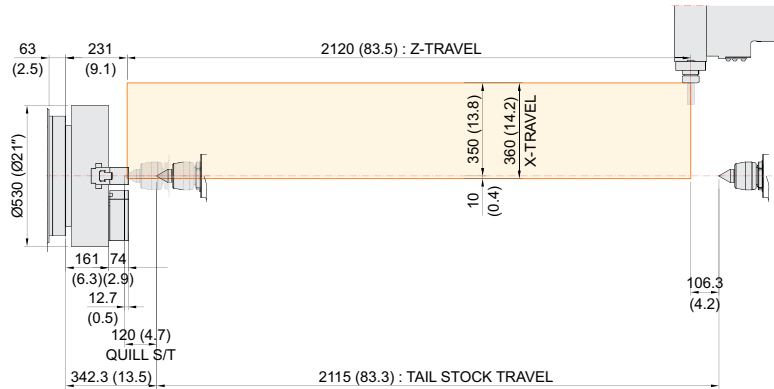

# SPECIFICATIONS

## Specifications

[ ] : Option

ITEM			L5100L	L5100LM
CAPACITY	Swing Over the Bed		mm(in) Ø1,030 (Ø40.6")	
	Swing Over the Carriage		mm(in) Ø850 (Ø33.5")	
	Max. Turning Dia.		mm(in) Ø760 (Ø29.9") [12T Turret : Ø630 (Ø24.8")]	
	Max. Turning Length		mm(in) 2,205 (86.8")	
	Bar Capacity		mm(in) Ø165 (Ø6.5")	
SPINDLE	Chuck Size		inch 21" [24"] (Hydraulic)	
	Spindle Bore		mm(in) Ø181 (Ø7.1")	
	Spindle Speed (rpm)		r/min 1,500	
	Motor (Max/Cont.)		kW(HP) 45/37 (60/50)	
	Torque (Max/Cont.)		N·m(lbf·ft) 4,112/3,382 (3,032.9/2,494.4) 2,990/2,459 (2,205.3/1,813.6)	
	Spindle Type		-	
	Spindle Nose		-	
	C-axis Indexing		deg 0.001	
FEED	Travel	X/Z	mm(in) 400/2,255 (15.7"/88.8")	
	Rapid Traverse Rate	X/Z	m/min(ipm) 20/18 (787/709)	
	Slide Type		-	
TURRET	No. of Tools		ea 10 [12] 12	
	Tool Size	OD	mm(in) □ 32 (□ 1 1/4")	
		ID	mm(in) Ø60 (Ø2 1/2")	
	Indexing Time		sec/step 0.25	
LIVE TOOL	Milling Tool Speed (rpm)		r/min - 4,000	
	Motor (Max/Cont.)		kW(HP) - 23/7.5 (31/10)	
	Torque (Max/Cont.)		N·m(lbf·ft) - 146/48 (107.7/35.4)	
	Collet Size		mm(in) - ER40-Ø26 (1)	
	Type		- BMT75	
TAIL STOCK	Taper		-	
	Quill Dia.		mm(in) MT#6 : Live-center [MT#5 : Built-In] Ø120 (Ø4.7")	
	Quill Travel		mm(in) 120 (4.7")	
	Travel		mm(in) 2,115 (83.3")	
TANK CAPACITY	Coolant Tank		ℓ (gal) 500 (132.1)	
	Lubricating Tank		ℓ (gal) 4 (1.1)	
POWER SUPPLY	Electric Power Supply		kVA 50	
	Thickness of Power Cable		mm <sup>2</sup> Over 50	
	Voltage		V/Hz 220/60 (200/50)	
MACHINE	Floor Space (L×W)		mm(in) 6,235×2,978 (245.5"×117.2")	
	Height		mm(in) 2,315 (91.1")	
	Weight		kg(lb) 13,000 (28,660) 13,200 (29,101)	
CNC	Controller		-	
HYUNDAI WIA FANUC i Series - Smart Plus				

\* Prior consultation is required when applying spindle contouring control for gear driven spindle.



# SPECIFICATIONS

## Specifications

[ ] : Option

ITEM			L5100LC	L5100LMC
CAPACITY	Swing Over the Bed	mm(in)	Ø1,030 (Ø40.6")	
	Swing Over the Carriage	mm(in)	Ø850 (Ø33.5")	
	Max. Turning Dia.	mm(in)	Ø760 (Ø29.9") [12T Turret : Ø630 (Ø24.8")]	Ø690 (Ø27.2")
	Max. Turning Length	mm(in)	2,205 (86.8")	2,120 (83.5")
	Bar Capacity	mm(in)	Ø275 (Ø10.8")	
SPINDLE	Chuck Size	inch	[24" (Pneumatic, Independent)]	
	Spindle Bore	mm(in)	Ø276 (Ø10.9")	
	Spindle Speed (rpm)	r/min	1,000	
	Motor (Max/Cont.)	kW(HP)	45/37 (60/50)	
	Torque (Max/Cont.)	N·m(lbf·ft)	4,486/3,689 (3,308.7/2,720.9)	
	Spindle Type	-	2 Step Gear + Belt	
	Spindle Nose	-	ISO 702-4 No.20	
	C-axis Indexing	deg	0.001	
FEED	Travel	X/Z mm(in)	400/2,255 (15.7"/88.8")	400/2,170 (15.7"/85.4")
	Rapid Traverse Rate	X/Z m/min(ipm)	20/18 (787/709)	
	Slide Type	-	Box Guide	
TURRET	No. of Tools	ea	10 [12]	12
	Tool Size	OD mm(in)	□ 32 (□ 1 1/4")	
		ID mm(in)	Ø60 (Ø2 1/2")	
	Indexing Time	sec/step	0.25	
LIVE TOOL	Milling Tool Speed (rpm)	r/min	-	4,000
	Motor (Max/Cont.)	kW(HP)	-	23/7.5 (31/10)
	Torque (Max/Cont.)	N·m(lbf·ft)	-	146/48 (107.7/35.4)
	Collet Size	mm(in)	-	ER40-Ø26 (1)
	Type	-	-	BMT75
TAIL STOCK	Taper	-	MT#6 : Live-center [MT#5 : Built-In]	
	Quill Dia.	mm(in)	Ø120 (Ø4.7")	
	Quill Travel	mm(in)	120 (4.7")	
	Travel	mm(in)	2,115 (83.3")	
TANK CAPACITY	Coolant Tank	ℓ (gal)	500 (132.1)	
	Lubricating Tank	ℓ (gal)	4 (1.1)	
POWER SUPPLY	Electric Power Supply	kVA	50	
	Thickness of Power Cable	mm <sup>2</sup>	Over 50	
	Voltage	V/Hz	220/60 (200/50)	
MACHINE	Floor Space (L×W)	mm(in)	6,455×2,978 (254.1"×117.2")	
	Height	mm(in)	2,315 (91.1")	
	Weight	kg(lb)	13,300 (29,322)	13,500 (29,762)
CNC	Controller	-	HYUNDAI WIA FANUC i Series - Smart Plus	

※ Prior consultation is required when applying spindle contouring control for gear driven spindle.

# SPECIFICATIONS

## Specifications

[ ] : Option

ITEM			L5100LY	
CAPACITY	Swing Over the Bed		mm(in)	Ø1,030 (Ø40.6")
	Swing Over the Carriage		mm(in)	Ø850 (Ø33.5")
	Max. Turning Dia.		mm(in)	Ø610 (Ø24")
	Max. Turning Length		mm(in)	2,070 (81.5")
	Bar Capacity		mm(in)	Ø165 (Ø6.5")
SPINDLE	Chuck Size		inch	2 1"
	Spindle Bore		mm(in)	Ø181 (Ø7.1")
	Spindle Speed (rpm)		r/min	1,500
	Motor (Max/Cont.)		kw(HP)	45/37 (60/50)
	Torque (Max/Cont.)		N·m(lbf·ft)	2,990/2,459 (2,205.3/1,813.6)
	Spindle Type		-	2 Step Gear + Belt
	Spindle Nose		-	A1-15
	C-axis Indexing		deg	0.001
FEED	Travel	X/Y/Z	mm(in)	360/150 (±75)/2,120 (14.2"/5.9"(±3")/83.5")
	Rapid Traverse Rate	X/Y/Z	m/min(ipm)	20/12/18 (787/472/709)
	Slide Type		-	Box Guide
TURRET	No. of Tools		ea	12
	Tool Size	OD	mm(in)	□ 32 (□ 1 1/4")
		ID	mm(in)	Ø60 (Ø2 1/2")
	Indexing Time		sec/step	0.25
LIVE TOOL	Milling Tool Speed (rpm)		r/min	4,000
	Motor (Max/Cont.)		kw(HP)	23/7.5 (31/10)
	Torque (Max/Cont.)		N·m(lbf·ft)	146/48 (107.7/35.4)
	Collet Size		mm(in)	ER40-Ø26 (1)
	Type		-	BMT75
TAIL STOCK	Taper		-	MT#6 : Live-center [MT#5 : Built-In]
	Quill Dia.		mm(in)	Ø120 (Ø4.7")
	Quill Travel		mm(in)	120 (4.7")
	Travel		mm(in)	2,115 (83.3")
TANK CAPACITY	Coolant Tank		ℓ (gal)	500 (132.1)
	Lubricating Tank		ℓ (gal)	4 (1.1)
POWER SUPPLY	Electric Power Supply		kVA	50
	Thickness of Power Cable		mm <sup>2</sup>	Over 50
	Voltage		V/Hz	220/60 (200/50)
MACHINE	Floor Space (L×W)		mm(in)	6,235×2,978 (245.5"×117.2")
	Height		mm(in)	2,515 (99")
	Weight		kg(lb)	14,000 (30,864)
CNC	Controller		-	HYUNDAI WIA FANUC i Series - Smart Plus

\* Prior consultation is required when applying spindle contouring control for gear driven spindle.

# CONTROLLER

## HYUNDAI WIA FANUC i Series – Smart Plus

[ ] : Option

Controlled axis / Display / Accuracy Compensation	
Control axis	2 axis (X, Z) / 3 axis (X, Z, C) / 4 axis (X, Z, Y, C) 5 axis (X, Z, B, C, A) / 6 axis (X, Z, Y, B, C, A) 7 axis (X1/Z1, X2/Z2, B2, C1/C2)
Simultaneously controlled axis	2 axis [Max. 4 axis]
Designation of spindle axis	3 axis [Max. 4 axis]
Least setting Unit	X, Z, Y, B axis : 0.001 mm (0.0001 inch) C, A axis : 0.001 deg
Least input increment	X, Z, Y, B axis : 0.001 mm (0.0001 inch) C, A axis : 0.001 deg
Inch / Metric conversion	G20 / G21
High response vector control	
Interlock	All axis / Each axis
Machine lock	All axis
Backlash compensation	± 0~9999 pulses (exc. Rapid traverse / Cutting feed)
Position switch	
LCD / MDI	15 inch LCD unit (with Touch Panel)
Feedback	Absolute motor feedback
Stored stroke check 1	Over travel
Stored stroke check 2, 3	
PMC axis control	
Operation	
Automatic operation (Memory)	
MDI operation	
DNC operation	Needed DNC software / CF card
Program restart	
Wrong operation prevention	
Program check function	Dry run
Single block	
Search function	Program Number / Sequence Number
Interpolation functions	
Nano interpolation	
Positioning	G00
Linear interpolation	G01
Circular interpolation	G02, G03
Exact stop mode	Single : G09, Continuous : G61
Dwell	G04, 0 ~ 9999.9999 sec
Skip	G31
Reference position return	1st reference : G28, 2nd reference : G30 Ref. position check : G27
Thread synchronous cutting	G33
Thread cutting retract	
Variable lead thread cutting	
Multi / Continuous threading	
Feed function / Acc. & Dec. control	
Manual feed	Rapid traverse Jog : 0~2,000 mm/min (79 ipm) Manual handle : x1, x10, x100 pulses Reference position return
Cutting Feed command	Direct input F code
Feedrate override	0 ~ 200% (10% Unit)
Rapid traverse override	1%, F25%, 50%, 100%
Override cancel	
Feed per minute	G98
Feed per revolution	G99
Look-ahead block	1 block
Program input	
Tape Code	EIA / ISO
Optional block skip	9 ea
Program stop / end	M00, M01 / M02, M30
Maximum command unit	± 999,999.999 mm (± 99,999.9999 inch)
Plane selection	X-Y : G17 / Z-X : G18 / Y-Z : G19
Workpiece coordinate system	G52, G53, 6 pairs (G54 ~ G59)
Manual absolute	Fixed ON
Programmable data input	G10
Sub program call	10 folds nested
Custom macro	#100 ~ #199, #500 ~ #999
G code system	A, B/C
Programmable mirror image	G51.1, G50.1
G code preventing buffering	G4.1
Direct drawing dimension program	Including Chamfering / Corner R
Conversational Program	SmartGuide-i

Program input	
Multiple repetitive cycles	I, II
Canned cycle for turning	
Auxiliary function / Spindle speed function	
Auxiliary function	M & 4 digit
Level-up M Code	High speed / Multi / Bypass M code
Spindle speed function	S & 5 digit, Binary output
Spindle override	0% ~ 150% (10% Unit)
Multi position spindle orientation	M19 (S##)
Rigid tapping	
Constant surface speed control	G96, G97
Tool function / Tool compensation	
Tool function	T & 2 digit + Offset 2 digit
Tool life management	
Tool offset pairs	128 pairs
Tool nose radius compensation	G40, G41, G42
Geometry / Wear compensation	
Direct input of offset measured B	
Editing function	
Part program storage size	5,120m (2MB)
No. of registerable programs	1,000 ea
Program protect	
Background editing	
Extended part program editing	Copy, move and change of NC program
Memory card program edit	
Data input / output & Interface	
I/O interface	CF card, USB memory Embedded Ethernet interface
Screen hard copy	
External message	
External key input	
External workpiece number search	
Automatic data backup	
Setting, display and diagnosis	
Self-diagnosis function	
History display & Operation	Alarm & Operator message & Operation
Run hour / Parts count display	
Maintenance information	
Actual cutting feedrate display	
Display of spindle speed / T code	
Graphic display	
Operating monitor screen	Spindle / Servo load etc.
Power consumption monitoring	Spindle & Servo
Spindle / Servo setting screen	
Multi language display	Support 24 languages
Display language switching	Selection of 5 optional Languages
LCD Screen Saver	Screen saver
Unexpected disturbance torque	BST (Back spin torque limit)
Function for machine type	
Cs contour control (C & A axis)	Mill, MS, Y, SY, LF-Mill, TTMS, TTSY
Polar coordinate interpolation	Mill, MS, Y, SY, LF-Mill, TTMS, TTSY
Cylindrical interpolation	Mill, MS, Y, SY, LF-Mill, TTMS, TTSY
Polygon turning (2 Spindles)	Mill, MS, Y, SY, LF-Mill, TTMS, TTSY
Canned cycle for drilling	Mill, MS, Y, SY, LF-Mill, TTMS, TTSY
Spindle orientation expansion	MS, SY, TTS, TTMS, TTSY
Spindle synchronous control	MS, SY, TTS, TTMS, TTSY
Torque control	MS, SY, TTS, TTMS, TTSY
Y axis offset	Y, SY, TTSY
Arbitrary angular control	Y, SY, TTSY
Composite / Superimposed control	MS, SY, TTS, TTMS, TTSY
Balance cutting	TTS, TTMS, TTSY
Option	
Fast ethernet	Needed option board
Data server	Needed option board
Protection of data at 8 levels	
Tool offset pairs	200 pairs
Helical interpolation	
Optional block skip	40 ea, 200 ea (AICC II)

Figures in inch are converted from metric values.

The FANUC controller specifications are subject to change based on the policy of company CNC supplying.



**You Tube HYUNDAI WIA MT**  
[www.youtube.com/HYUNDAIWIAMT](http://www.youtube.com/HYUNDAIWIAMT)

## CREATING VALUE IN SEAMLESS MOBILITY

With its top-quality HYUNDAI WIA machine tool creates a new and better world.



<http://machine.hyundai-wia.com>  
HYUNDAI WIA Machine Tools  
Global Links

### HEADQUARTER

**R&D Center/Factory** 153, Jeongdong-ro, Seongsan-gu, Changwon-si, Gyeongsangnam-do, Korea TEL : +82 55 280 9114 FAX : +82 55 282 9114

**Overseas Sales Team /R&D Center** 37, Cheoldobangmulgwan-ro, Uiwang-si, Gyeonggi-do, Korea TEL : +82 31 8090 2539

### OVERSEAS OFFICES

**HYUNDAI WIA Machine America corp.** 450 Commerce Blvd, Carlstadt, NJ 07072, USA TEL : +1-201-987-7298

**HYUNDAI WIA Europe GmbH** Alexander-Fleming-Ring 57, 65428 Rüsselsheim Germany TEL : +49-0-6142-9256-0

**HYUNDAI WIA Machine Tools China** Company No.16 Fenghuang Road, Fenghuang Town, Zhangjiagang City, Jiangsu Province, China TEL : +86-21-6427-9885

**India Branch Office** #4/169, 1st Floor, LOTTE BLDG, Rajiv Gandhi Salai, (OMR), Kandanchavadi, Chennai - 600096, Tamilnadu, India TEL : +91-76-0490-3348